

EUzebox DIY kit

construction manual

by

H. Wendt

Rev.	Date	Description
A	2011-07-05	First release
B	2011-07-28	Spelling corrections on page 2 Bug fix on page 10: new reference for 1,5K resistors

You need the following tools:

*a regulated soldering iron
(25..40W) with small tip*



*a wet sponge to clean the
tip*



thin solder wire



a diagonal cutter for wires



Needle nose pliers



A basic multimeter is not required but recommend



Bag 1 - Power Supply



1x
Power socket
(S1)



1x
Bridge rectifier
(BR1)



1x
electrolytic capacitor
470uF / 25V
(C2)



1x
capacitor
100nF
(C4)

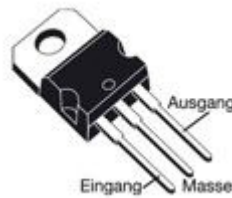

1x
5V voltage regulator
7805
(IC2)

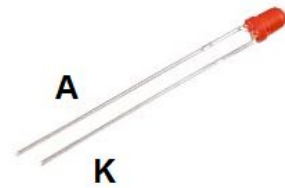

1x
LED red, 3mm
(D1)



1x
electrolytic capacitor
10uF / 10V
(C5)

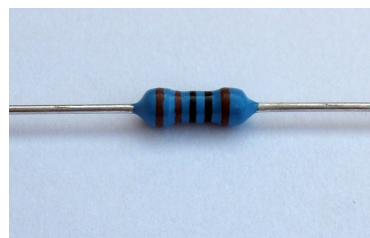

brown, black, black, brown, brown

1x
resistor
1k / 1%
(R7)



1x
M3 screw, 8mm



1x
M3 hexagon nut

1.) *assemble the power socket (S1) and bridge rectifier (BR1)*

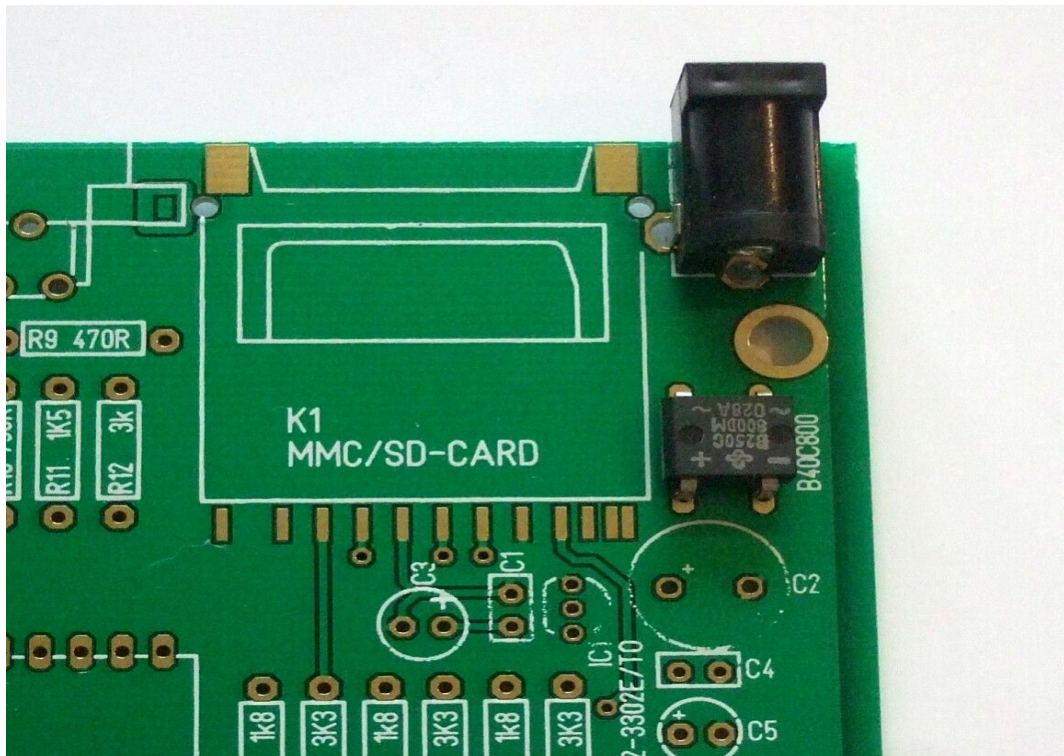

2.) *assemble the condensators (C2, C4, C5)*

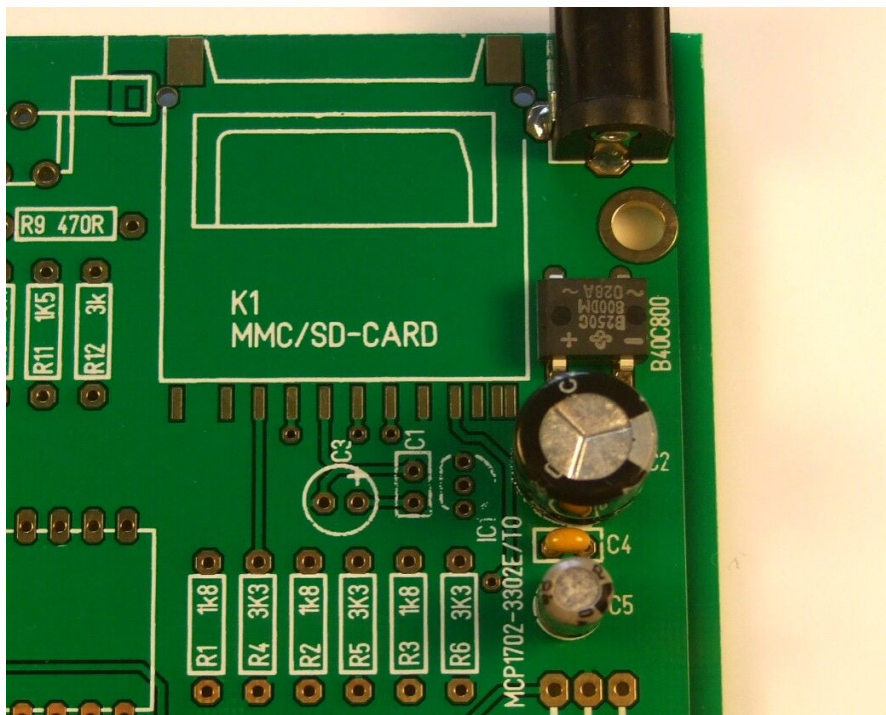

3.) assemble the voltage regulator 7805 (IC2)

- 3.1 bend the connector pins 90° with a tong
- 3.2 mount the voltage regulator with screw and nut
- 3.3 solder the voltage regulator

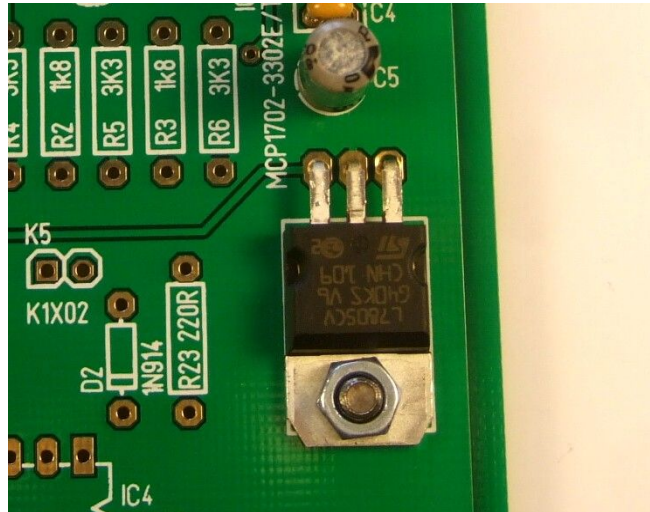

4.) assemble the LED (D1) and 1K resistor (R7)

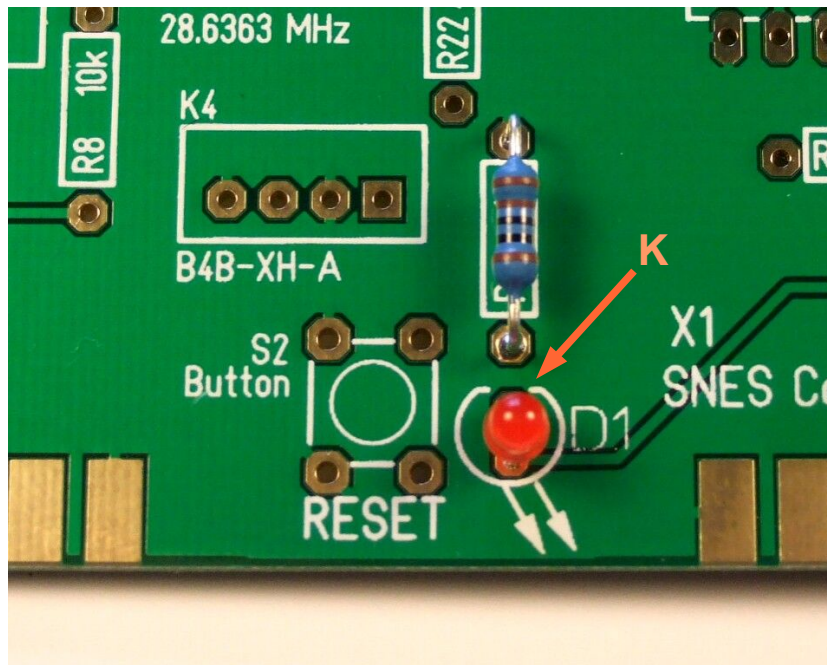

5.) *Check the function of 5V power supply*

5.1 *connect a 9V power supply to S1*

5.2 *measure the out vantageof IC2:*

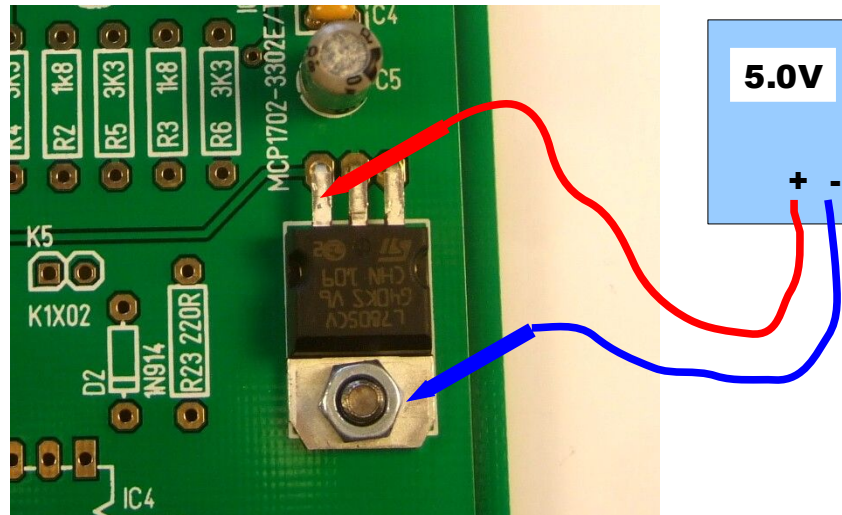

5.3 *check the function of the red LED D1:*

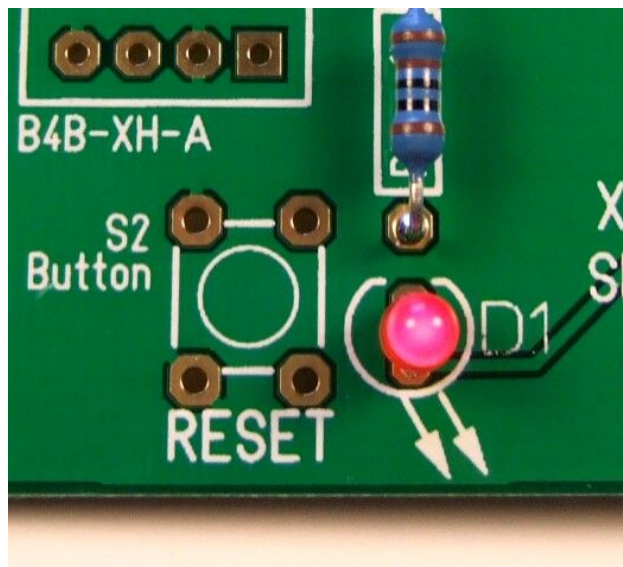

5.4 *disconnect the external power supply!*

Bag 2 – microcontroller & SCART interface



1x
IC socket



1x
microcontroller
ATMEGA644
(IC3)



1x
crystal
28,6363 MHz
(Q1)



1x
capacitor
100nF
(C7)

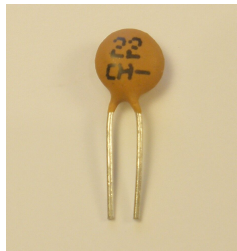

2x
capacitor
22pF
(C6, C8)



1x
SCART socket
(K3)

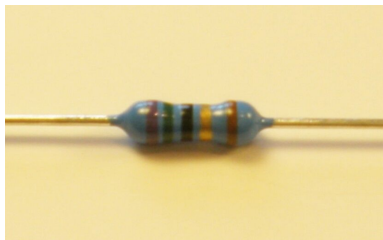

purple, green, black, gold, brown

3x
resistor
75 Ohm / 1%
(R18, R19, R20)

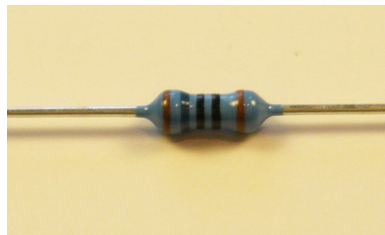

brown, blue, black, black, brown

1x
resistor
160 Ohm / 1%
(R21)

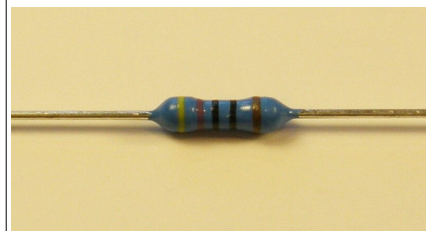

yellow, purple, black, black, brown

1x
resistor
470 Ohm / 1%
(R9)

Contruction manual EUzebox DIY kit – Rev B

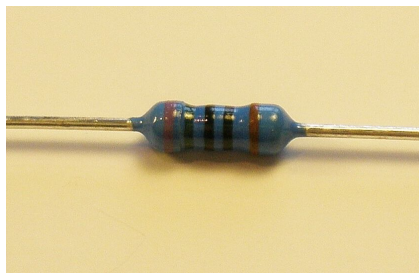

purple, green, black, black, brown

3x
resistor
750 Ohm / 1%
(R10, R13, R16)

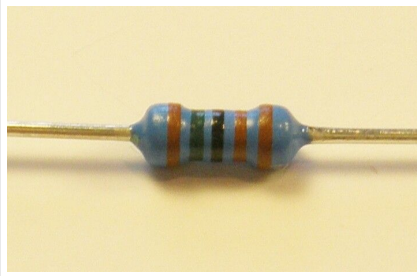

brown, green, black, brown, brown

3x
resistor
1,5K / 1%
(R11, R14, R17)

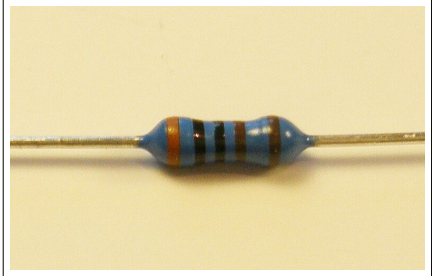

Orange, black, black, brown, brown

2x
resistor
3K / 1%
(R12, R15)

6.) *assemble the IC socket*

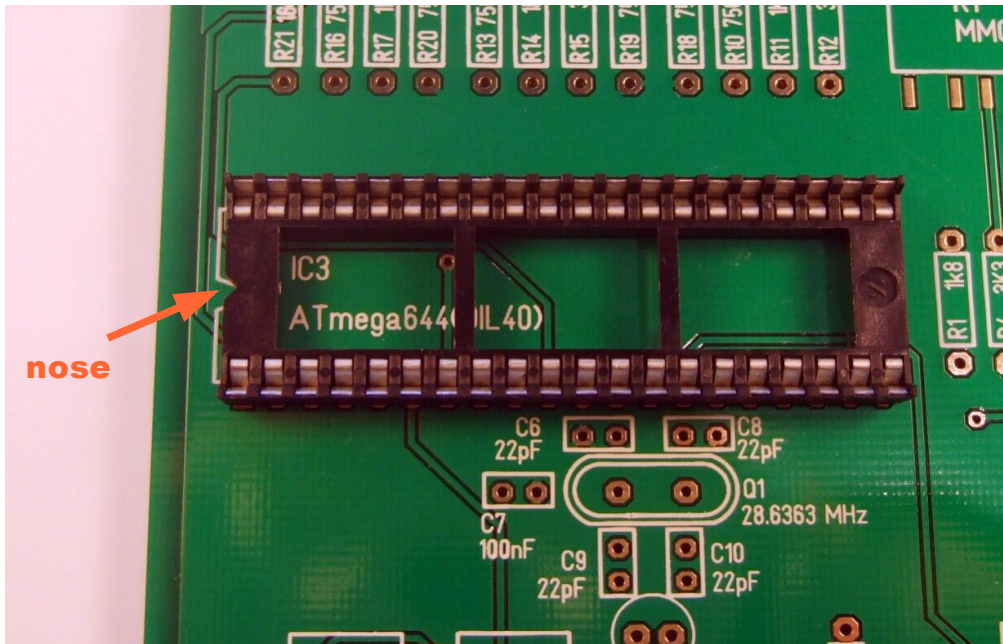

7.) *Assemble the crystal (Q1) and capacitors (C6, C7, C8)*

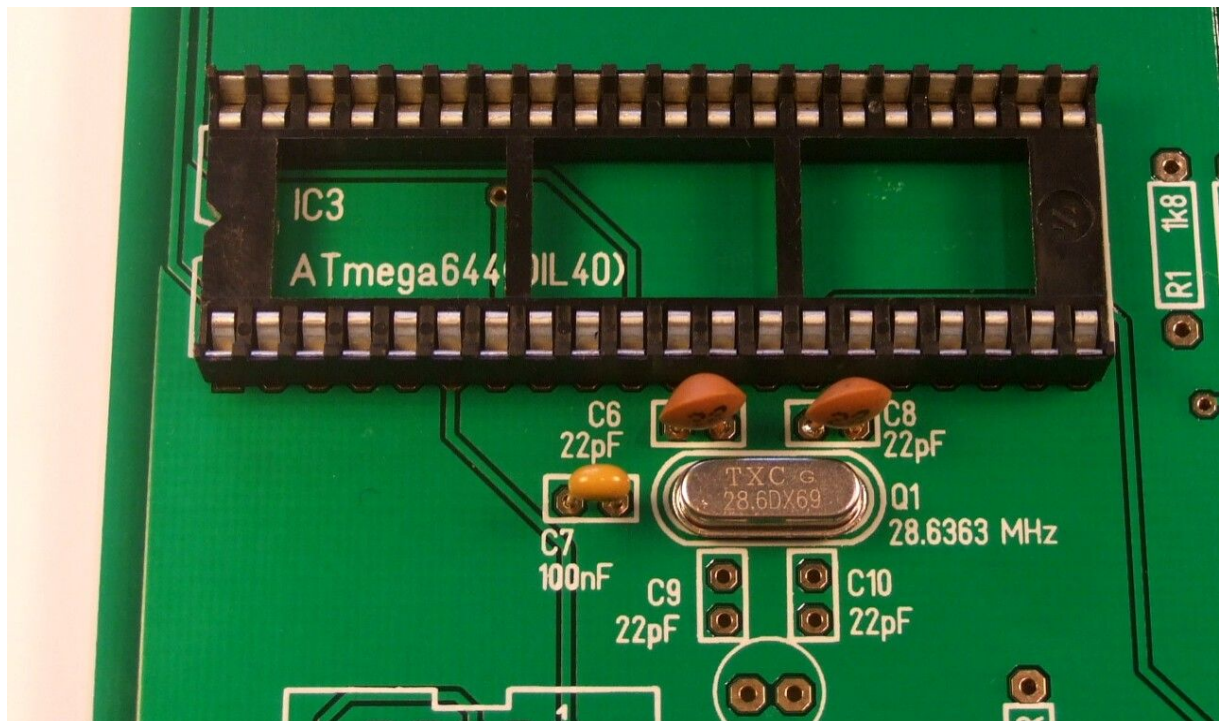

8.) assemble the 160Ohm resistor (R21)

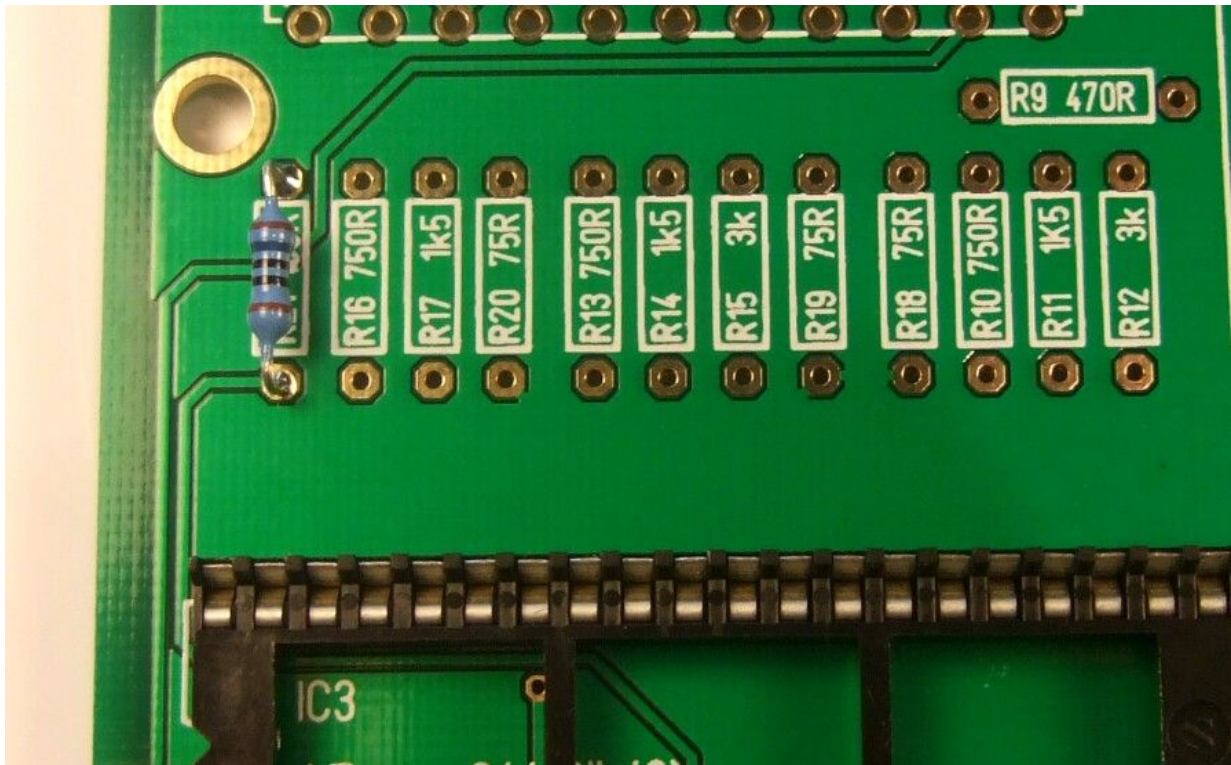

9.) assemble the 470Ohm resistor (R9)

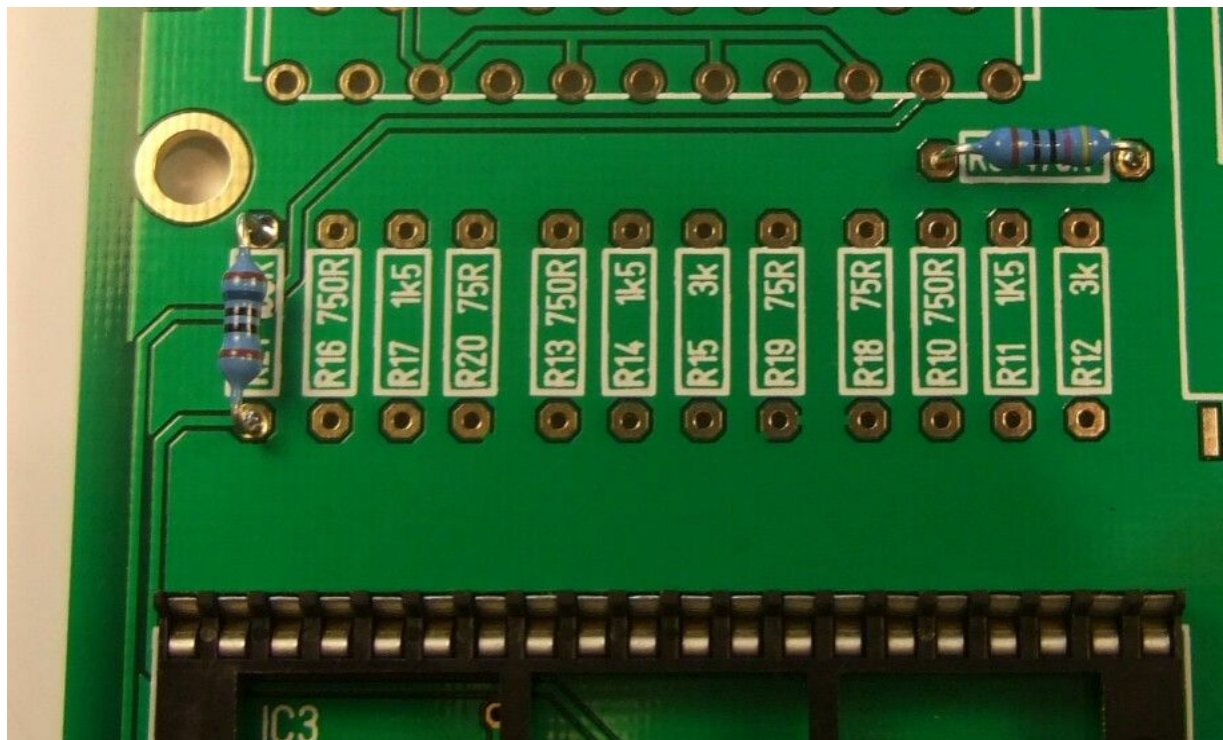

10.) assemble the 3K resistors (R12, R15)

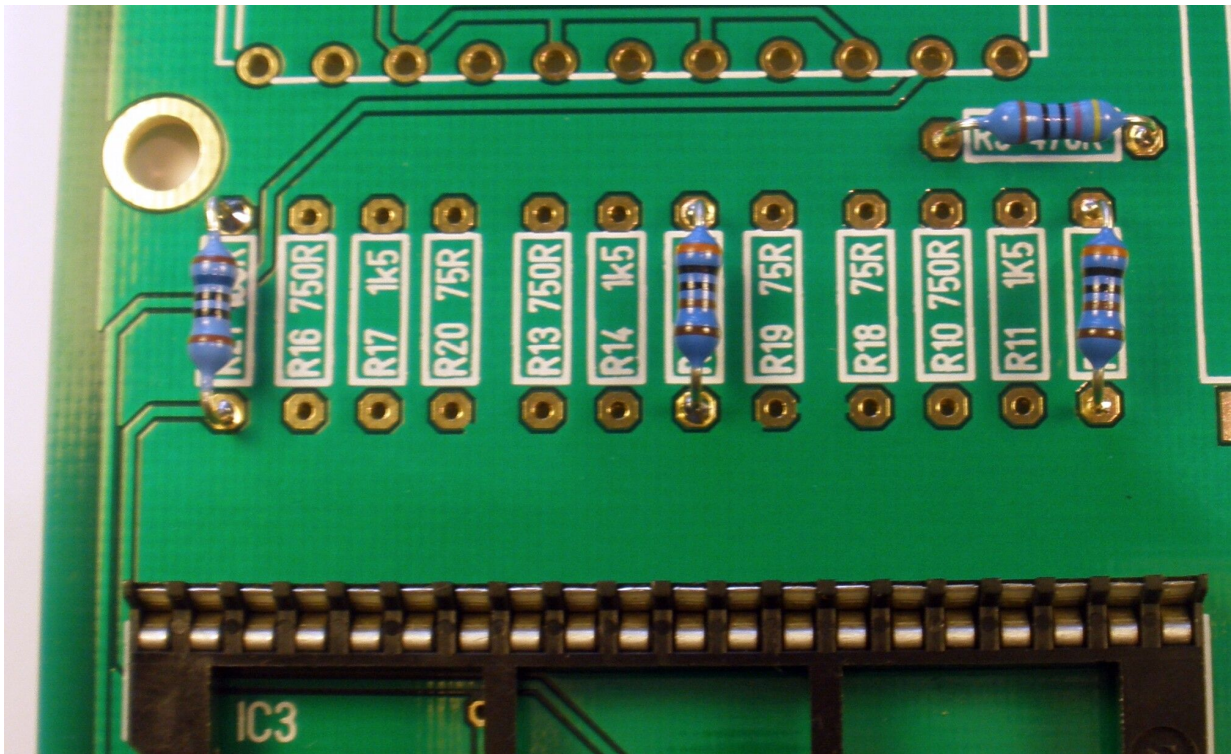

11.) assemble the 1,5K resistors (R11 R14, R17)

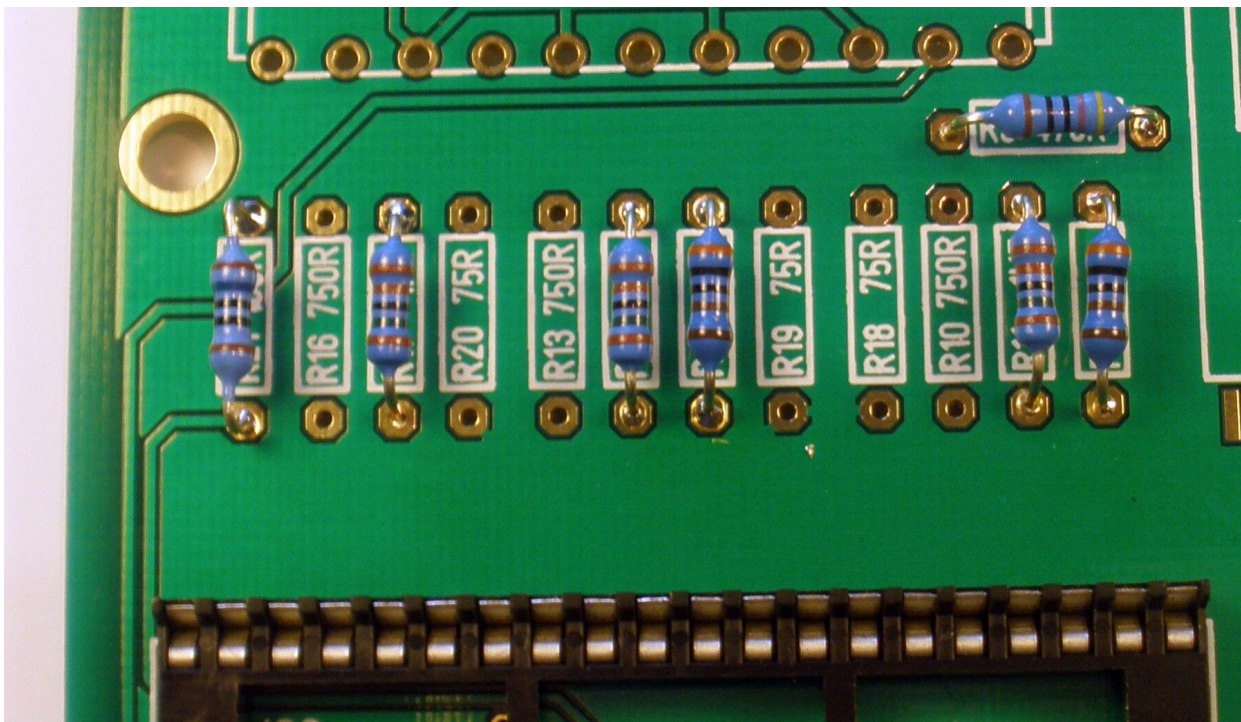

12.) assemble the 750Ohm resistors (R10, R13, R16)

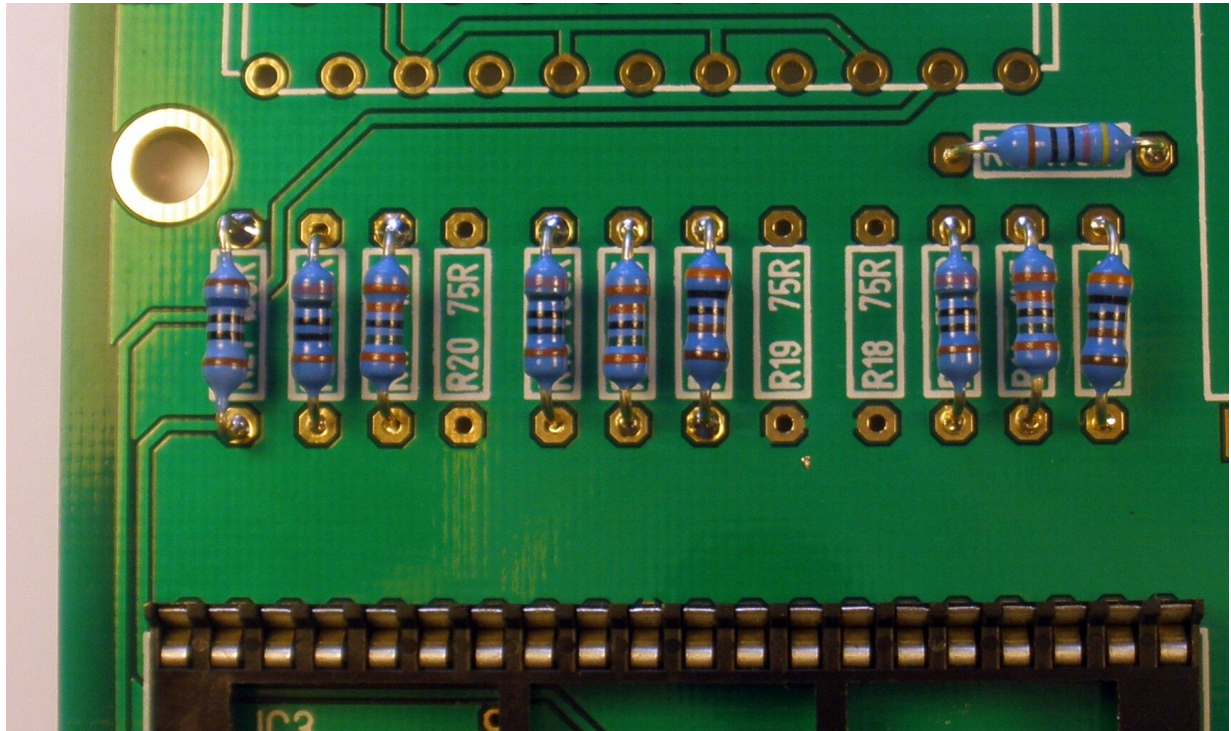

13.) assemble the 750Ohm resistors (R18, R19, R20)

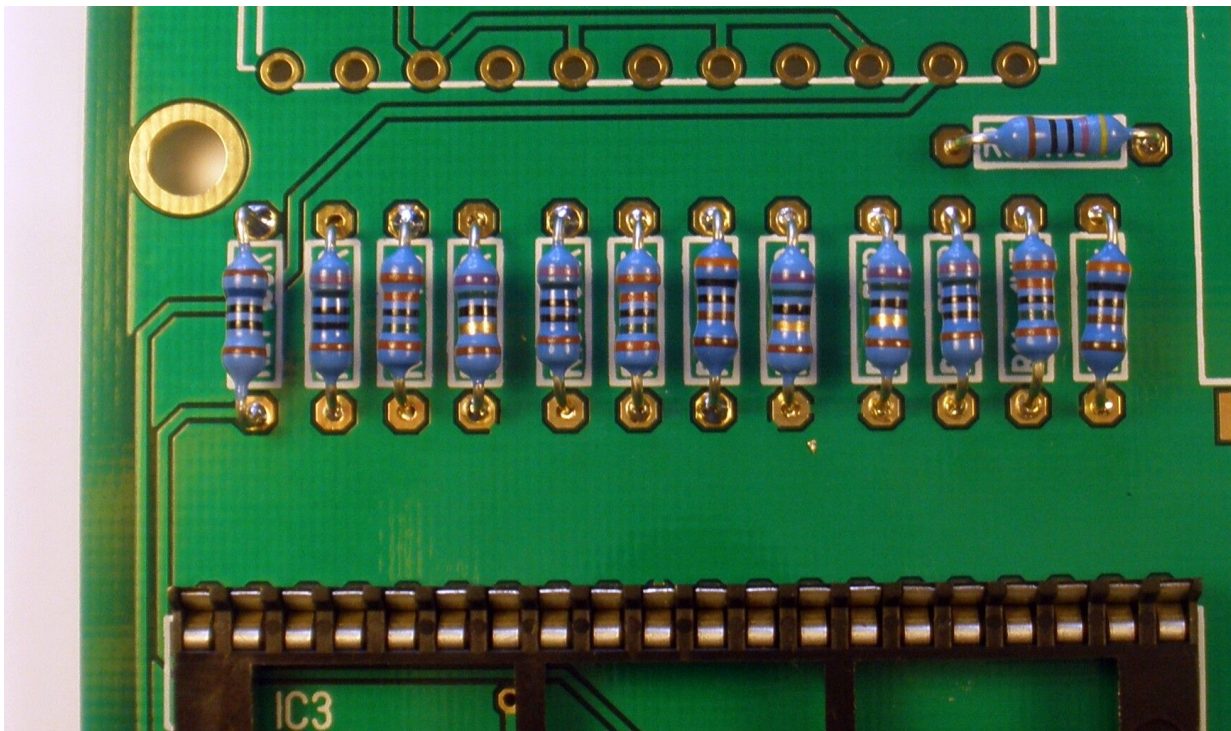

14.) assemble the SCART connector (K3)

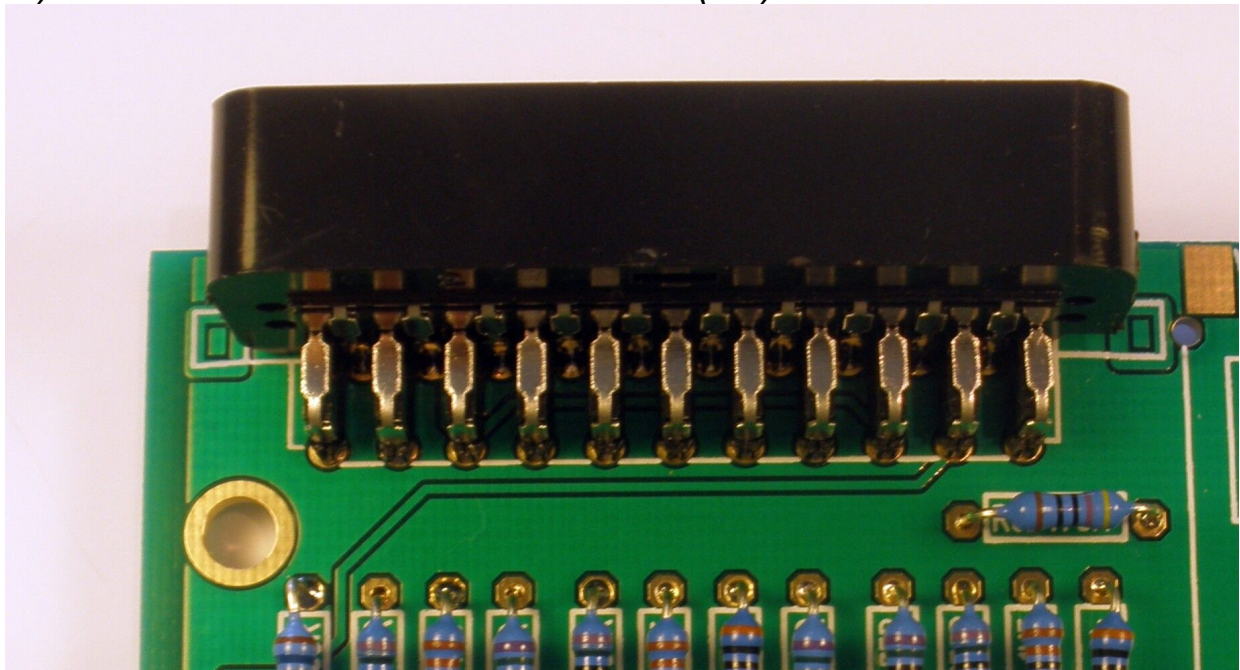

15.) mount the ATMEGA644 (IC3)

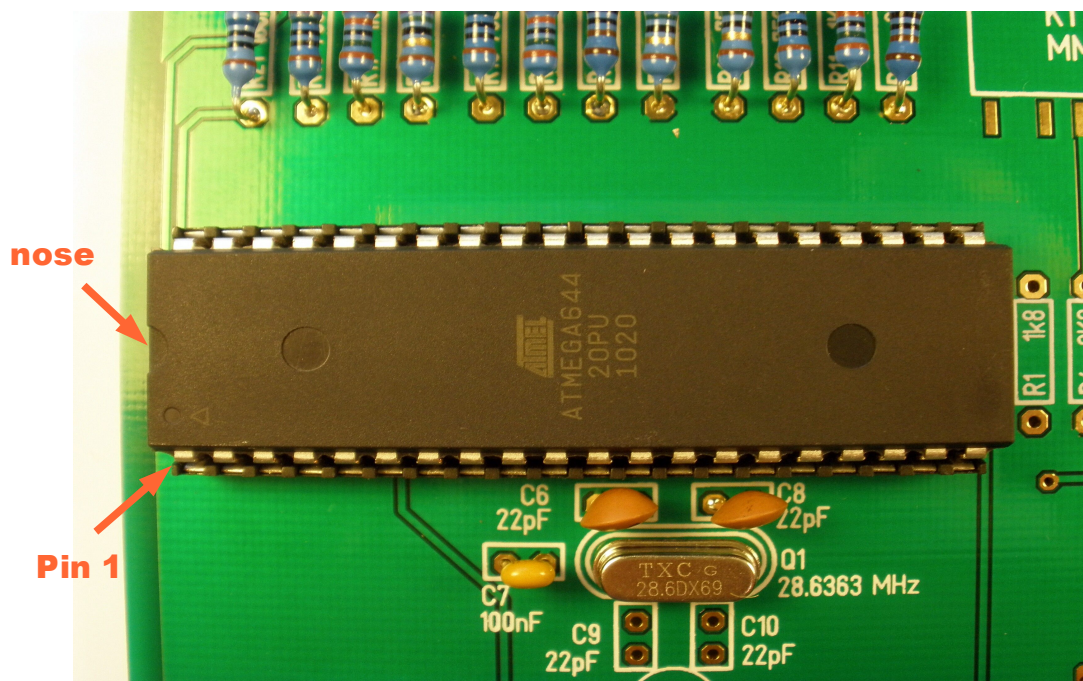

16.) Check the video interface

16.1 connect the 9V power supply to S1

16.2 connect a SCART cable between K3 and the TV set

16.3 you should see this picture on your TV set

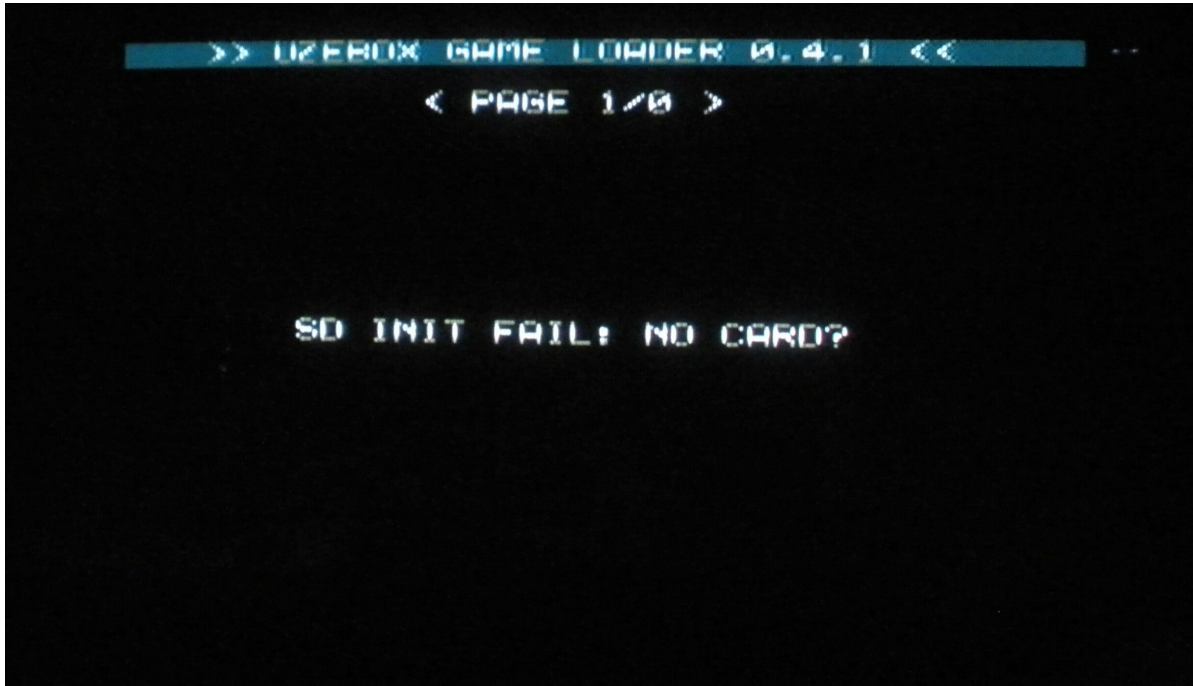

16.4 disconnect the power supply!!!

Bag 3 – SD card interface & SNES sockets



1x
SD card connector
(K1)



1x
ISP header
(K2)



1x
reset button
(S2)



1x
capacitor
100nF
(C1)



1x
electrolytic capacitor
1uF / 63V
(C3)



GND V_{IN} V_{OUT}
1x
3,3V low drop voltage
regulator
MCP1702-3302E
(IC1)

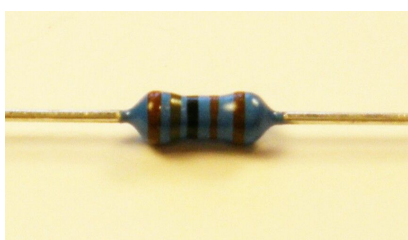

brown, grey, black, brown, brown

3x
resistor
1,8k / 1%
(R1, R2, R3)

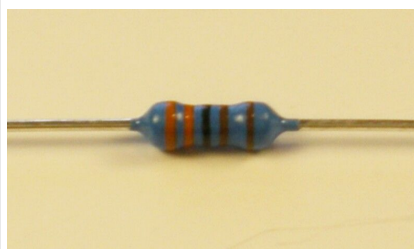

orange, orange, black, brown, brown

3x
resistor
3,3k / 1%
(R4, R5, R6)



brown, black, black, red, brown

1x
resistor
10k / 1%
(R8)



2x
SNES gamepad socket
(X1, X2)

17.) Assemble ISP header (K2) and 10k resistor (R8)

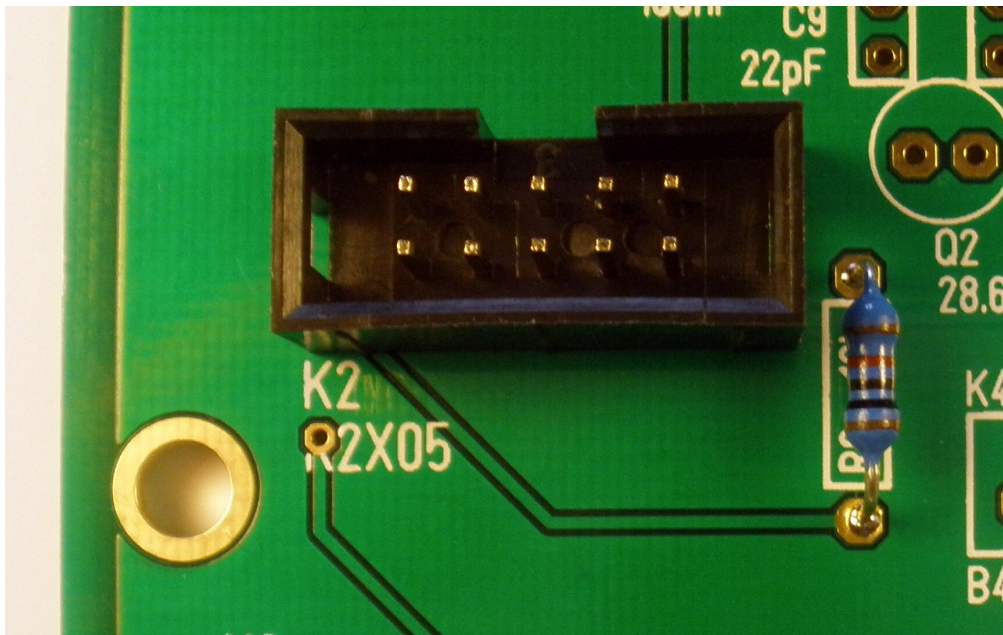

18.) Assemble reset button (S2)

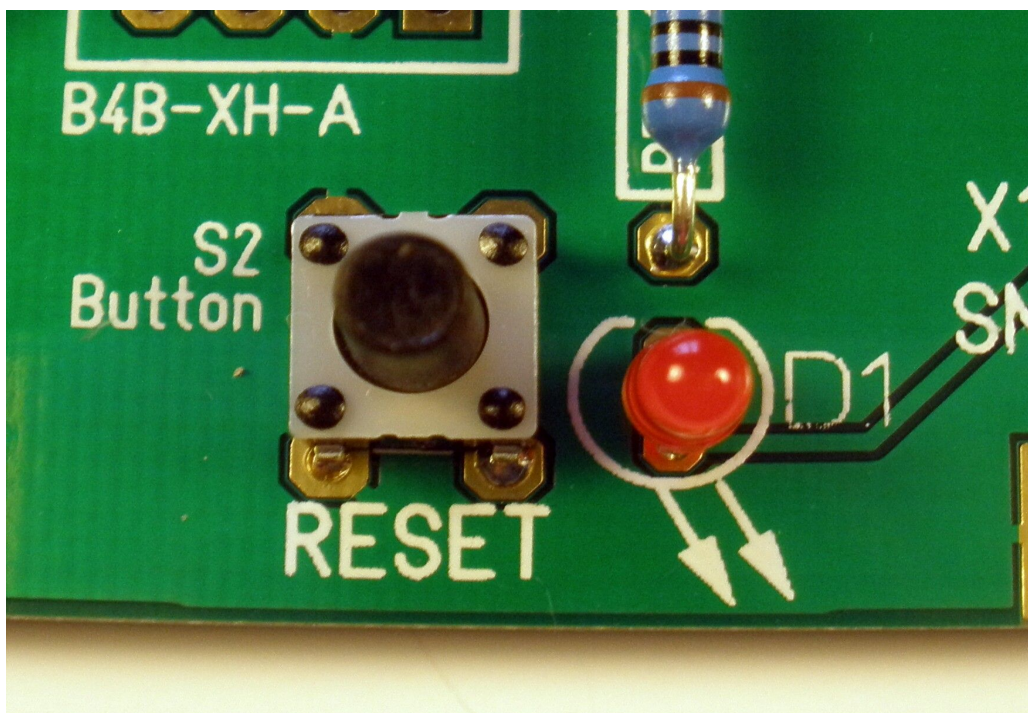

19.) Assemble SD card socket (K1)

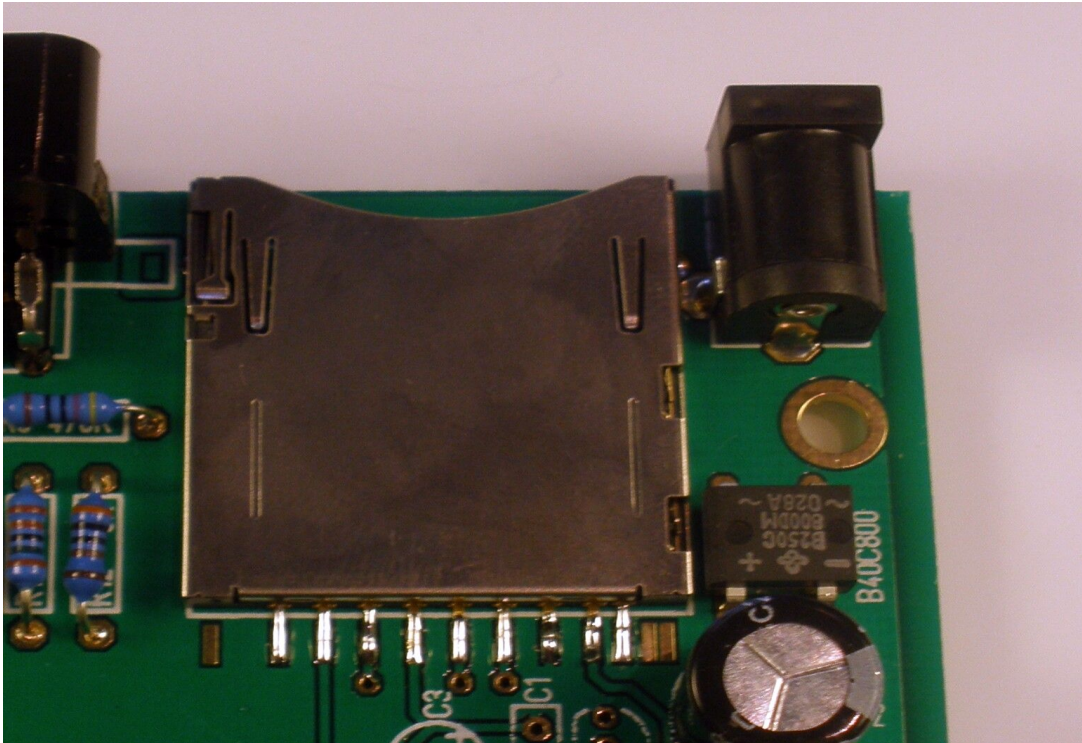

Don't forget to solder the fixing pins at backside:



20.) Assemble the 3,3V power supply (C1, C3, IC1)

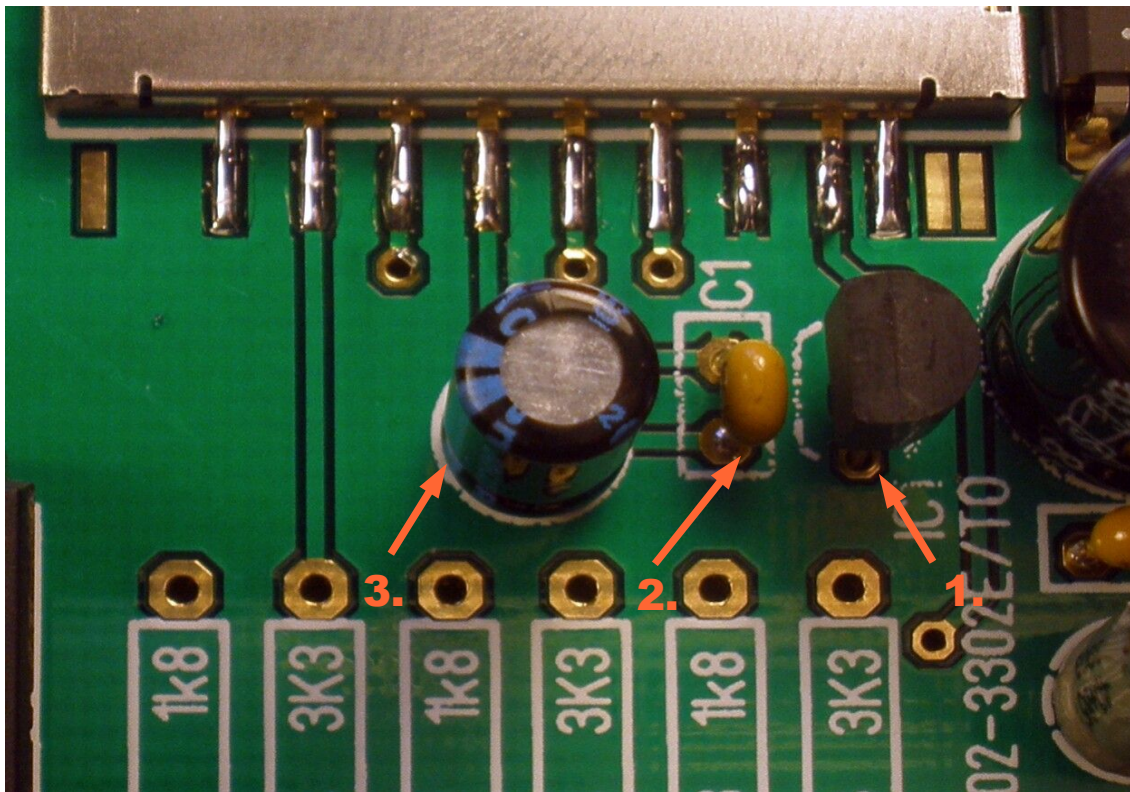

21.) Assemble the 3,3K resistors (R4, R5, R6)

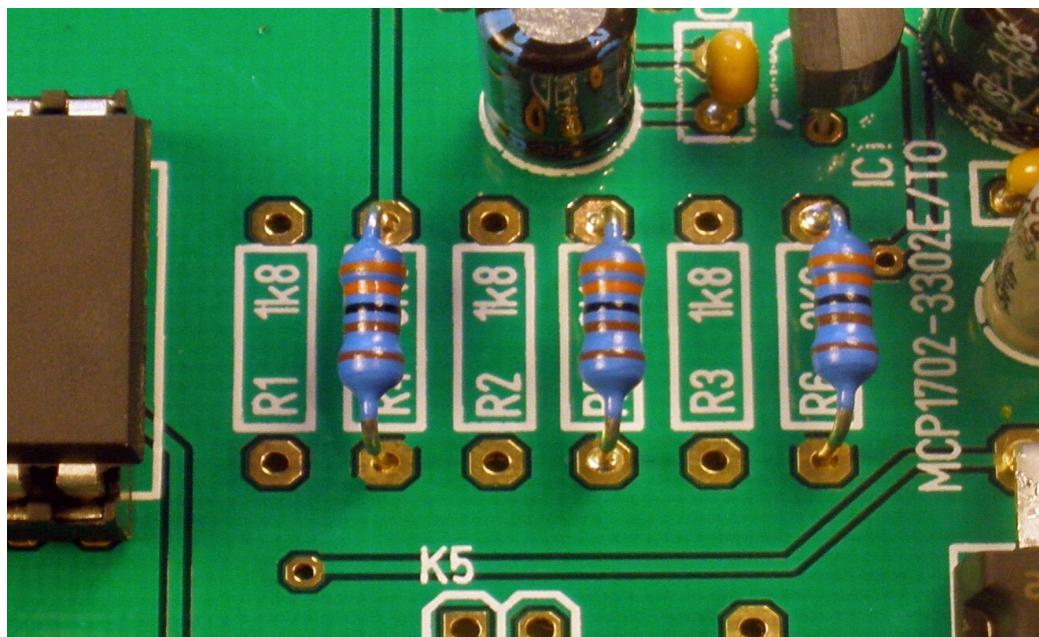

22.) Assemble the 1,8k resistors (R1, R2, R3)

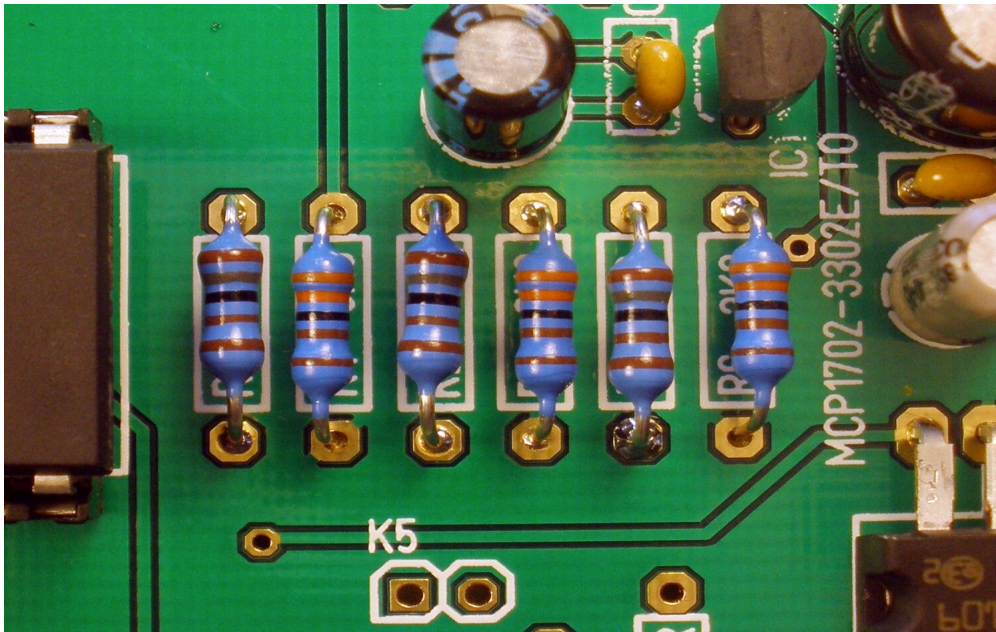

23.) Assemble the SNES gamepad sockets (X1, X2)

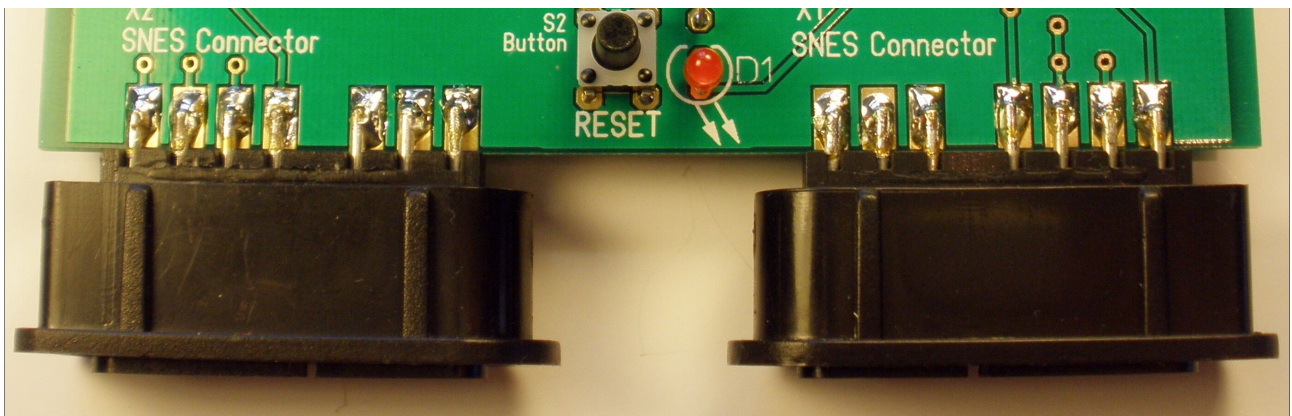

Attention. If you want to mount the PCB in a Hammond case then you have to plug the connectors through the frontplate **before** soldering!

24.) Check the function of the EUzebox

- 24.1 connect the 9V power supply to S1
- 24.2 connect a SCART cable between K3 and the TV set
- 24.3 connect a SNES gamepad to X2 (left socket)
- 24.4 you should now see this picture on your TV set



- 24.5 try to move the arrow with the up/down buttons
- 24.6 select 1 Player and press button A

Congratulation – your Euzebox works!

Trouble shooting:

Problem	Solution
LED D1 don't shine	<ul style="list-style-type: none"> - check the output voltage of your power supply (9..12V AC or DC) - check the output of IC2 with the multimeter (4.9V to 5.1V is ok) - check the direction of the LED
No picture	<ul style="list-style-type: none"> - check the direction of mounted IC3 - check the soldering of Q1, C6 C8 - check the soldering of all resistor of SCART interface - TV set is switched to the SCART input? - SCART input is full assembled? - try another TV set
Picture with wrong colors	<ul style="list-style-type: none"> - check the soldering of SCART connector - check the soldering of all resistor of SCART interface - check SCART interface of short circuits
SD card don't work	<ul style="list-style-type: none"> - measure the output voltage of IC1 (measure the voltage between Pin3 and 4 of K1 – 3,3V required) - check the soldering of K1 - try other SD cards - format the SD card again with FAT16
No sound	<ul style="list-style-type: none"> - check the soldering of R9