

M-Bus Master Shield

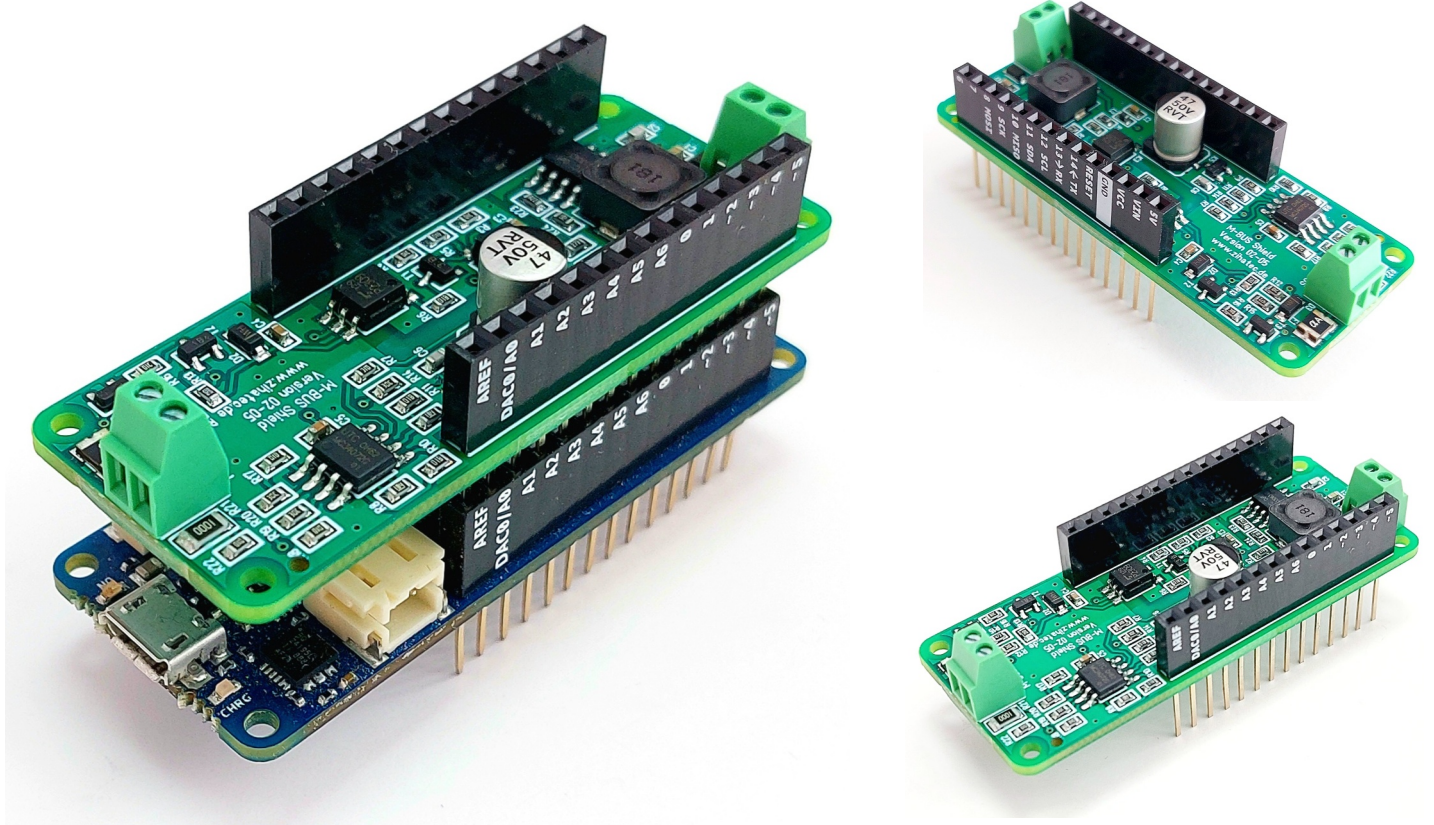

for Arduino MKR series



Features:

- M-Bus (Meter-Bus) master
- Compatible to European standard EN 13757-2
- For the remote reading of consumption meters
- For up to 6 unit-loads (9mA)
- External DC power supply (9...30V) needed
- Galvanically isolated interface
- Miniature screw terminals for bus and power supply connection
- Stacked headers
- For Arduino MKR series and Arduino Portenta H7 only

M-Bus Master Shield



for Arduino MKR series

Compatible Arduino MKR Boards:

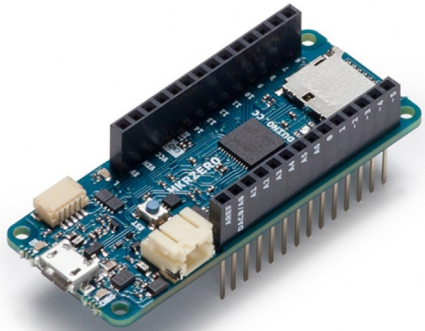

Arduino MKR ZERO



Arduino MKR1000

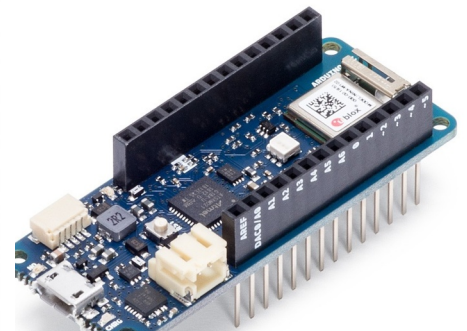

Arduino MKR WiFi 1010

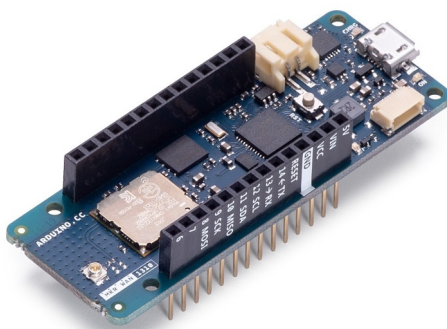

Arduino MKR WAN 1300/1310



Arduino MKR GSM 1400



Arduino MKR NB 1500

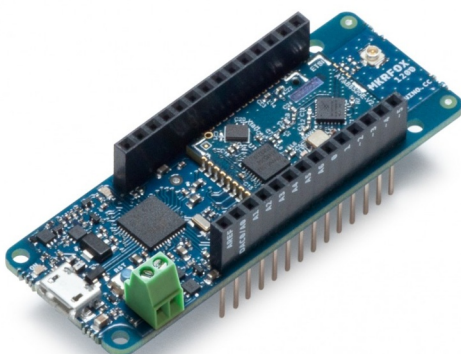

Arduino MKR FOX 1200



Arduino Portenta Family

M-Bus Master Shield



for Arduino MKR series

Part number table:

Part-No.	EAN	Version
ARDMKMB	0676424951534	Arduino MKR MBUS Master Shield

Used Arduino MKR Pins:

- 13 – RX
- 14 – TX

M-Bus Master Shield



for Arduino MKR series

Applications:

- Smart home
- Smart metering
- Green (solar) energy monitoring
- Remote sensor reading
- Remote control via M-Bus

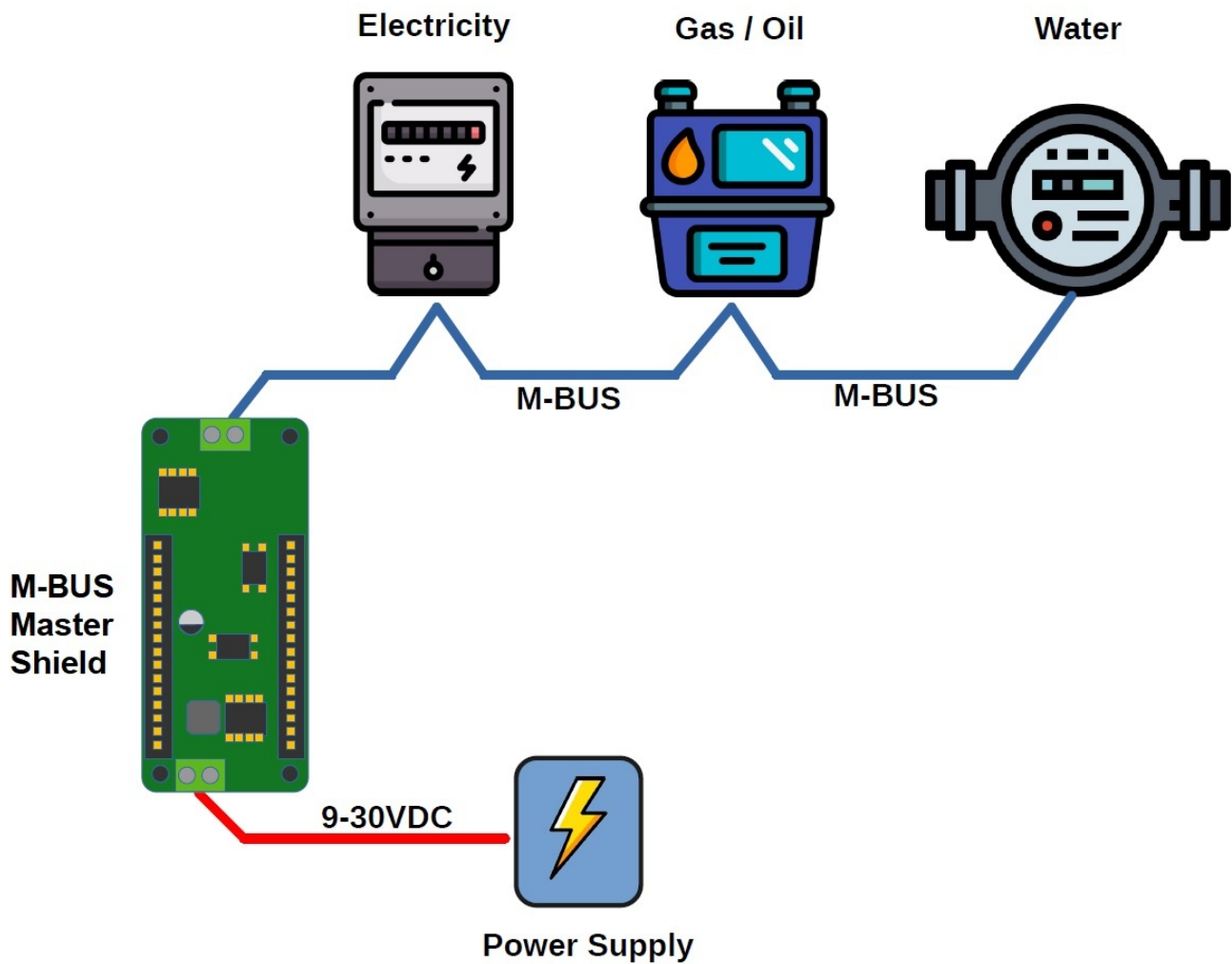

M-Bus Master Shield



for Arduino MKR series

Control Elements:

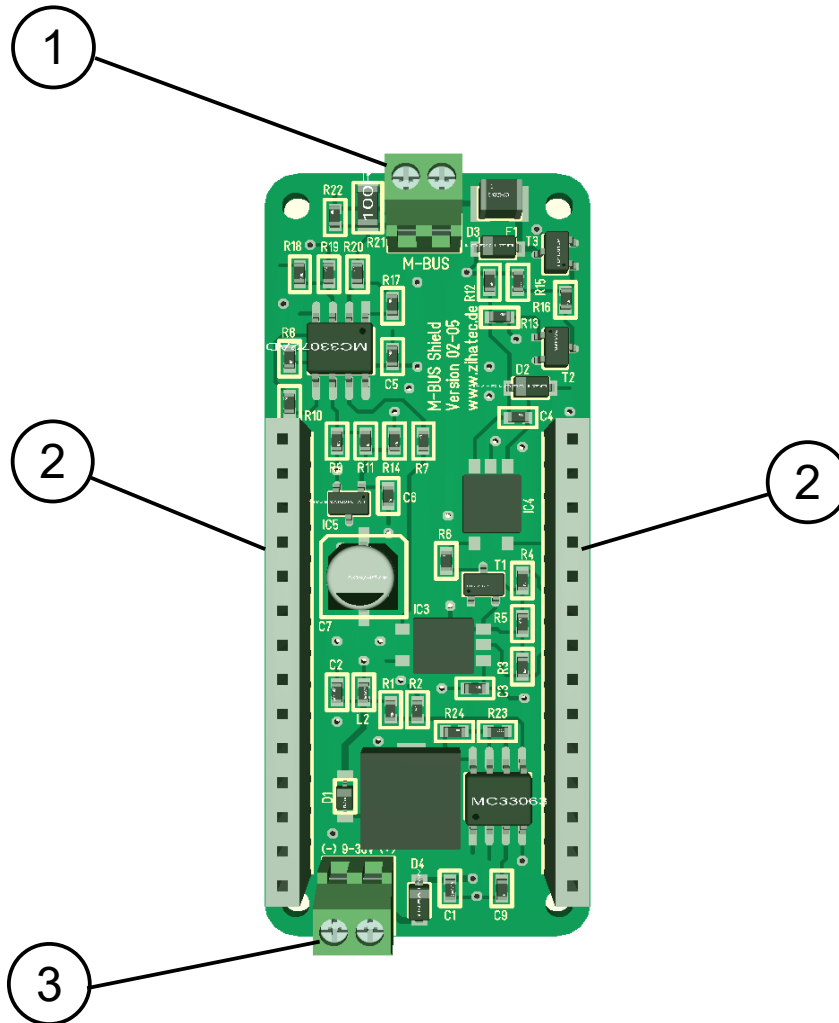

- ① M-Bus terminal
- ② stacked headers for Arduino MKR boards
- ③ terminal for power supply